

Maintenance & Operating Instructions

For

Dixon Bayco

FT7000

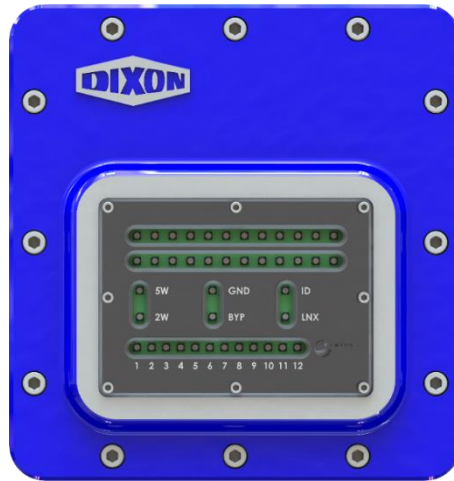

For Sales and Service Contact

Europe:
Dixon Group Europe Ltd.
Preston, England
Phone: +44 (0) 1772 323529
Fax: +44 (0) 1772 314664
Email: enquiries@dixoneurope.co.uk

Mexico:
Dixva, S. de R.L. de C.V.
Monterrey, N.L.
Phone: 01-800-00-DIXON (34966)
Fax: 01-81-8354-8197
E-mail: contactenos@dixonvalve.com.mx

Canada:
Dixon Group Canada Limited
Innisfil (Barrie), Ontario
Phone: 705-436-1125
Fax: 705-436-6251
Toll Free: 877-963-4966
E-mail: isales@dixongroupcanada.com

Asia Pacific:
Dixon (Asia Pacific) Pty Ltd Wingfield, South
Australia
Phone: +61 8 8202 6000
Fax: +61 8 8202 6099
E-mail: enquiries@dixonvalve.com.au

USA:
Dixon Bayco USA
Chestertown, Maryland
Phone: 410-778-2000
Fax: 410-778-4702
Toll Free: 800-355-1991
E-mail: dixonbayco@dixonvalve.com



The Right Connection®

dixonvalve.com

Table of Contents

Certifications	3
Product Overview	4
Compatibility	4
Interface	5
Remote Interface	6
Output Relays.....	6
Bypass	7
Trailer Identification and Verification	7
LINX Overfill detection system.....	7
Accessories	8
Technical Specifications	8
Installation.....	10
Mechanical.....	10
Electrical	13
Configuration	22
Maintenance	25
Replacement Parts.....	28
Managing Bypass Cards	31
Operation.....	32
Loading Procedure	34
Bypass Procedure.....	35
FAQ & Troubleshooting.....	36
Warranty	37
Support.....	37

Certifications

The FT7000 is approved by CSA for installation and use in Class 1 Division 1 Group CD, and Class 1 Zone 1 Group CD locations. The enclosure has explosionproof, flameproof, IP54 certifications.

○	DIXON BAYCO - WEST CHESTER, OH. USA	TYPE: FT7000 IEC60529 IP66	○
	SERIAL: YYMMDD-000 Ex/AEx dIb Ib [Ia Ga] IIB T4 Gb -20°C<T _a <60°C		
	SUITABLE FOR CL I DIV 1 GP C&D HAZ LOC AND PROVIDES I.S. CONNECTIONS FOR CL I DIV 1 GP C&D HAZ LOC IN ACCORDANCE WITH FLOTECH CONTROL DWG 11039-ATEX. SEAL FITTINGS RQD WITHIN 18" OF ENCL ENTRY FOR NORTH AMERICAN INSTALLATION. ENTRY THREADING: 1/2" NPT.		
	CONTAINS FCC ID: 2ADZBID-2. WARNING - DO NOT OPEN WHILE AN EXPLOSIVE ATMOSPHERE IS PRESENT. REFER TO MANUAL FOR FURTHER WARNINGS AND INSTL RQMTS. NE PAS OUVRIR LE BOÎTIER DANS UN ENVIRONNEMENT EXPLOSIF. RÉFÉRER AU MANUEL POUR LES PRÉCAUTIONS ET LES PROCÉDURES D'INSTAL.		
		   2813  II 2(1)G	
	ENTITY PARAMETERS:	RELAY CONTACTS:	MAINS SUPPLY:
○	Um=250V Uo=12.6V Io=0.187A	MAX 250VAC 5A	110-240VAC 50-60HZ
	Po=0.59W Co=7.4µF Lo=9.1mH		Pm=13W
			○

This product is compliant with the following standards:

- CSA C22.2 NO. 61010-1-12
- CSA C22.2 NO. 30-M1986
- CSA C22.2 NO. 157-92
- CSA C22.2 NO. 60079-0:11
- CSA C22.2 NO. 60079-1:11
- CSA C22.2 NO. 60079-11:14
- UL 61010-1
- UL 1203
- UL 913
- UL 60079-0
- UL 60079-1
- UL 60079-11
- IEC 60079-0
- IEC 60079-1
- IEC 60079-11
- IEC 60529
- EN 60079-0
- EN 60079-1
- EN 60079-11

Product Overview

Dixon prides itself in the quality and reliability of their products. Their mechanical and electronic equipment is designed to withstand the harsh environments that tankers are exposed to. Products are developed with safety, reliability, usability, and customer satisfaction as our primary focus.

Our overfill prevention equipment has been in use in the field since 2000 and continues to set the standard for reliability in the tanker industry. The FT7000 rack monitor is the missing piece to a full Dixon overfill prevention system. With Dixon products end-to-end, racks and haulers can operate with less downtime and greater confidence in the reliability of their rack.

Compatibility

The FT7000 is compatible with overfill sensors and systems designed to meet the API 1004 and/or EN13922 standards. Most industry standard equipment will fall under one or both standards. The monitor may also work with products not explicitly designed to either standard, if their operation is similar.

While idle, the FT7000 will continually check for both 2W and 5W trailers. Once a trailer is attached, the monitor will automatically detect what type of sensors are outfitted on the trailer, then switch to the appropriate mode of operation.

SENSORS

- 5-Wire (OPTIC) sensors; 1-12 sensors
- 2-Wire Black and White (THERMISTOR) sensors 1-8 sensors
- 2-Wire Grey-Grey Universal (THERMISTOR) sensors 1-8 sensors
- 2-Wire Analog THERMISTOR sensors 1-8 sensors
- Onboard monitors

IDENTIFICATION

- Trailer Identification modules

EARTHING/GROUND DEVICES

- Ground bolt/bolt/wire
- Ground loop/Restive bond

Note: Not compatible with float type sensors, or 3-wire analog thermistor sensors

Interface

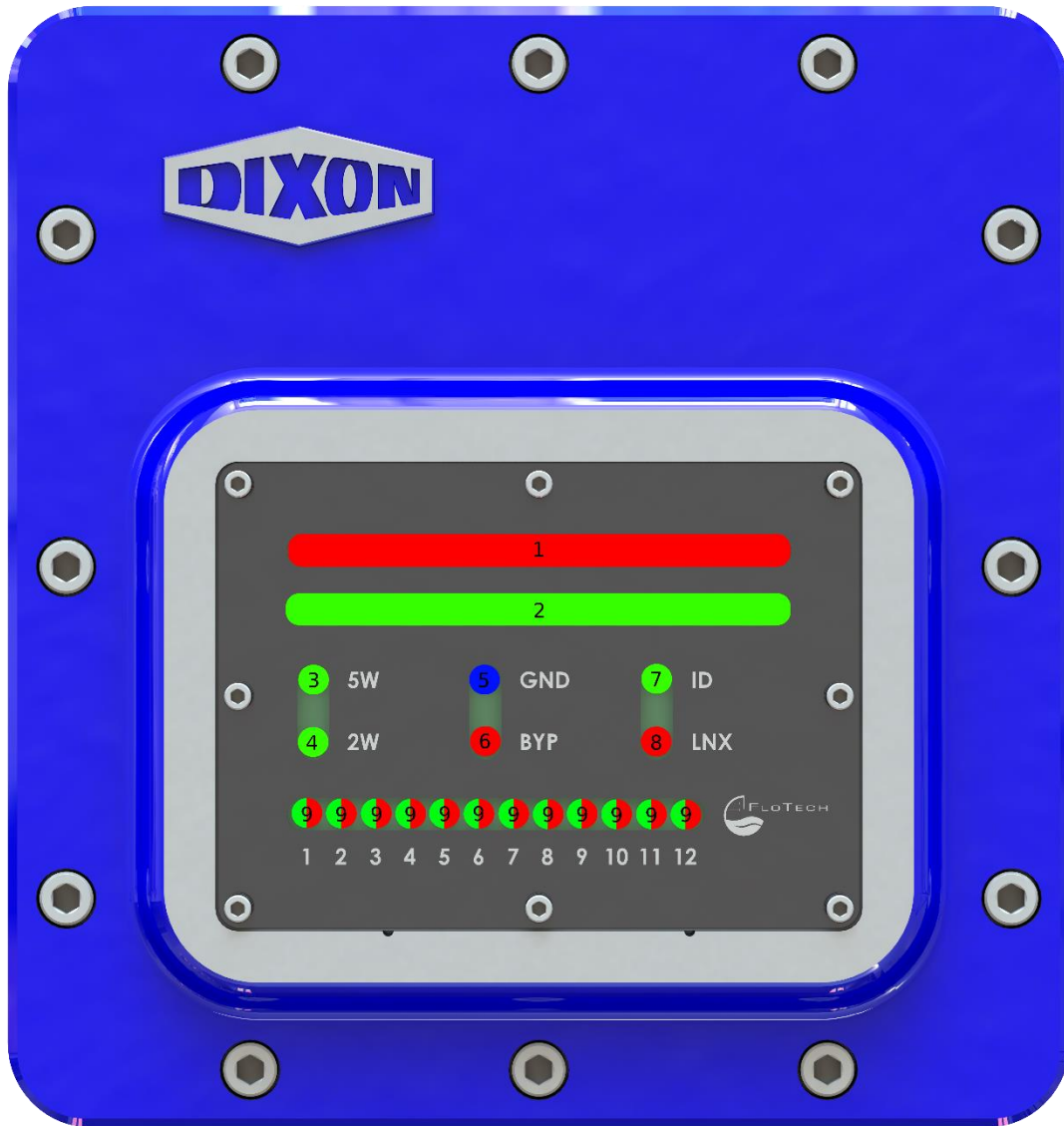

1. **NON-PERMIT** – The top row of indicators will illuminate red to reflect the state of the permit relays. While the indicators are on, the permit relays are de-energized.
2. **PERMIT** – The second row of indicators will illuminate green to reflect the state of the permit relays. While the indicators are on, the permit relays are energized.
3. **5WIRE SENSOR MODE** – Illuminates to indicate a trailer having 5 wire sensors has been attached and identified.
4. **2WIRE SENSOR MODE** – Illuminates to indicate a trailer having 2 wire sensors has been attached and identified.
5. **GROUND-OK** – The GND indicator will illuminate blue to reflect the state of the ground relay. While the indicator is on, the ground relay is energized. If no ground configurations are enabled the ground indicator and relay will be active constantly.

6. **BYPASS ACTIVE** – Indicator shows red when Overfill bypass is active, and blue when Ground bypass is active.
7. **ID FOUND** – The ID indicator will show green when a valid trailer identification module is found. When an unknown or expired trailer identification module is found the indicator will flash.
8. **OVERFILL DETECTED** – The LNX indicator reflects the state of the LINX relay contacts. When active, the attached trailer became non-permissive and is still attached. Refer to the LINX section below for more information about the LINX overfill detection system.
9. **COMPARTMENT INDICATORS** – Each compartment indicator can show either red or green to show the wet or dry status of the sensors, respectively. Indicators will be off if the compartment/sensor is not found, or unknown.

Remote Interface

The FT7000 is outfitted with an RS-485 port allowing the monitor to be managed remotely. Loading terminals having multiple loading lanes may monitor the status of all Rack monitors at a central computer using the RackView software. The FT7000's communications are Modbus compatible and may be connected onto an existing Modbus installation.

Output Relays

The FT7000 features 4 DRY FORM C (SPDT) relays. All relay contacts are dry and have Normally Open, Normally Closed, and Common contacts. All output relays are failsafe, featuring several methods of protection against failure

The relays feature a hardware feedback safety check that constantly monitors for any stuck or welded contacts. Should any relay's contacts become stuck or welded, the rack monitor will become non-permissive and de-energize all relays. Redundant Permit relays are used to ensure the permit contacts can always open even if one becomes stuck or welded. A hardware timeout circuit will automatically de-energize a relay that has not been verified within 400ms.

- **PERMIT** – The permit relay will energize once all enabled requirements have been met. This relay is often wired into the loading pump circuit, to interrupt loading if an unsafe condition occurs. The Relay will reflect the same state that the green and red indicators show on the front of the FT7000. Green indicates the permit relay is energized, while red indicates it is not energized.

If a ground device is enable, the permit relay will require dry overfill sensors and a good ground connection before energizing, otherwise dry sensors will permit. This relay is further protected against failure by having series redundant contacts. Should any contact become stuck or welded, the secondary relay can still open the contacts.

- **PERMIT** – A secondary permit relay allows the monitor to control 2 separate circuits. This relay features the same protections of the other permit relay but has its own fuse.
- **LINX**
The LINX relay indicates a true overfill situation. Refer to the LINX section below for more information about this feature.

- **GROUND**

The ground relay will energize when any of the enabled ground devices has been found. This relay will match the ground indicator on the front display. Removing the ground device will de-energize the relay.

Bypass

Trailers attempting to load may have a failed sensor or grounding device. In these situations, the terminal operator may deem the trailer safe to load and authorize a bypass using a bypass card. Once the FT7000 has been put into bypass mode, any of the following conditions will end the bypass:

- A trailer sensor becomes wet
- Rack cord is disconnected from trailer
- Bypass is manually ended
- 30 minutes has elapsed

Two types of bypass cards exist:

- **OVERFILL BYPASS CARD - This card will bypass ALL safety checks and can place the rack monitor into a permissive state.**
- **GROUND/TIM BYPASS CARD - This card will only bypass the ground checking function of the rack monitor.** Overfill sensors must still be operational.

Bypass cards can be removed or added, with a limit of 10 registered to an FT7000 at any given time. The same card may be used with several different FT7000 units. Refer to the Bypass Card Pairing Procedure for more information.

Trailer Identification and Verification

The FT7000 can read trailer identification modules and search its internal list of valid trailers. This function will not work without the use of the RS485 communications port and the RackView software. If the rack monitor is configured with ID enabled, all loading trailers must be outfitted with ID modules, added to the database in the RackView software, and be within their inspection period. Managing the approved trailer IDs and customers is done through the RackView software.

LINX Overfill detection system

The FT7000 distinguishes between a disconnected trailer and an overfilled trailer using the LINX overfill detection system. Traditional rack monitors will show red NON-PERMISSIVE signals while sitting idle, as well as while a tanker is overfilled. The rack operators have no visible way to determine the cause of the non-permit signal and therefore cannot judge the potential danger.

Unlike the traditional non-permit indicator, the LINX indicator will not be active while no trailer is connected to the rack monitor. The LINX indicator and relay will only active when a permissive trailer is attached then loses permissiveness. While the non-permissive trailer remains connected to LINX overfill detection system will indicate that an overfill is detected.

The LINX overfill detection system has limited functionality on FT7000 units with no grounding-device-detection enabled. Refer to the table below to determine if your trailers will be compatible with the

LINX overfill detection system.

	NO ONBOARD MONITOR		ONBOARD MONITOR	
	5-WIRE SENSORS	2-WIRE SENSORS	5-WIRE SENSORS	2-WIRE SENSORS
NO GROUND DEVICE ENABLED	NO	YES	NO	NO
1+ GROUND DEVICE ENABLED	YES	YES	YES	YES

Accessories

The FT7000 monitor can be set up to utilize either a Deadman switch or Emergency Stop switch. The switch must be Normally Open. A deadman switch will require the driver to actively hold a switch during the entirety of the loading process. Releasing the switch while loading will cause the FT7000 to go non-permissive.

Technical Specifications

	MIN	MAX	NOMINAL
INGRESS PROTECTION (IP)			IP66
SUPPLY VOLTAGE	110VAC	240VAC	
SUPPLY FREQ	50Hz	60Hz	
SUPPLY POWER		13W (8 probes)	6W (IDLE)
OPERATING TEMPERATURE	-20C/-4F	60C/140F	
HUMIDITY	0%	100%	
LENGTH			333mm/13.13"
WIDTH			316mm/12.44"
DEPTH			104mm/4.09"
WEIGHT			14.5KG/32LBS
RS-485 TERMINATION (optional)			120Ω
RELAY CONTACT RATING		240VAC 5A	
ACCEPTABLE WIRE GAUGE	12AWG	18AWG	
LID SCREW TORQUE	35 lb-ft		

Pollution Degree		2	
Overvoltage Category		II	
Usage Altitude		2000m above sea level	

FT7000 I.S. CIRCUIT ENTITY PARAMETERS						
TERMINAL	POS.	Uo	Io	Po	Co	Lo
J8	1	12.6V	187mA	0.59W	7.4uF	9.1mH
J8	2	12.6V	187mA	0.59W	7.4uF	9.1mH
J8	3	12.6V	187mA	0.59W	7.4uF	9.1mH
J8	4	12.6V	187mA	0.59W	7.4uF	9.1mH
J8	5	12.6V	187mA	0.59W	7.4uF	9.1mH
J8	6	12.6V	187mA	0.59W	7.4uF	9.1mH
J8	7	12.6V	187mA	0.59W	7.4uF	9.1mH
J8	8	12.6V	187mA	0.59W	7.4uF	9.1mH
J8	9	12.6V	187mA	0.59W	7.4uF	9.1mH
J8	10	GND	N/A	N/A	N/A	N/A
J9	1	12.6V	187mA	0.59W	7.4uF	9.1mH
J9	2	GND	N/A	N/A	N/A	N/A

Installation

INSTALLATION TO BE COMPLETED BY A QUALIFIED HAZARDOUS LOCATION TECHNICIAN.

L'INSTALLATION DOIT ÊTRE COMPLÉTÉ PAR UN TECHNICIEN QUALIFIÉ.

The FT7000 Rack monitor is suitable for installation in Class I Division 1/Zone 1 hazardous locations as defined by NEC NFPA70 and IECEx standard 60079. Installation to be performed by a qualified professional.

Mechanical

The recommended mounting method is using the included carriage bolts. This method will require that the back side of the installation surface be accessible. If this mounting method will not work, the enclosure may be installed using lag bolts, however caution should be taken to ensure the monitor is securely installed.

- Using the bolt pattern provided below, locate a sturdy area, large enough to install the monitor.

Keep in mind the lid hinge will open 180° to the right. Conduit may run to the left, right, and bottom sides of the monitor. The FT7000 should be positioned vertically at eye level, with indicators facing the lane, for greatest visibility. The enclosure can withstand rain and sun exposure, but will last longer when protected from the elements. Using the bypass function will require the face of the FT7000 to be reachable.

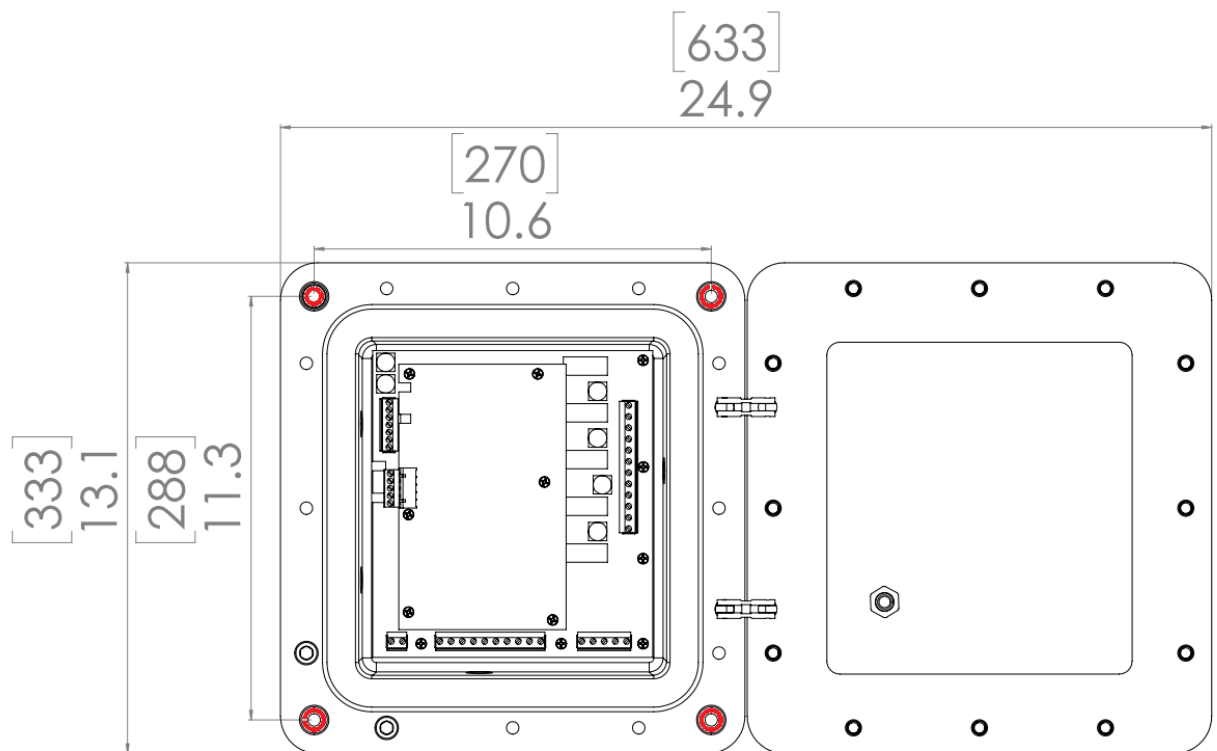

- Level the bolt pattern and drill four holes marked on the pattern.

- Remove the twelve lid screws, then open the lid. Ensure that the rubber gasket remains in position.

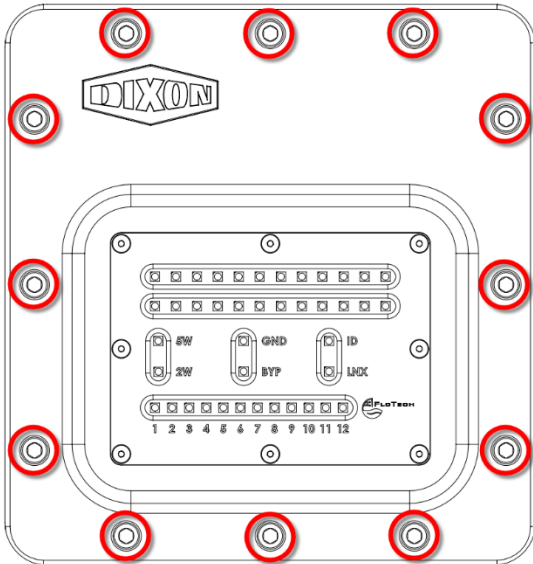

- With the lid open, have another person lift the monitor into position in front of the drilled holes.
- Insert the four carriage/lag bolts into the four mounting holes shown below. If using carriage bolts, thread the nuts onto the back of each bolt before releasing the monitor.

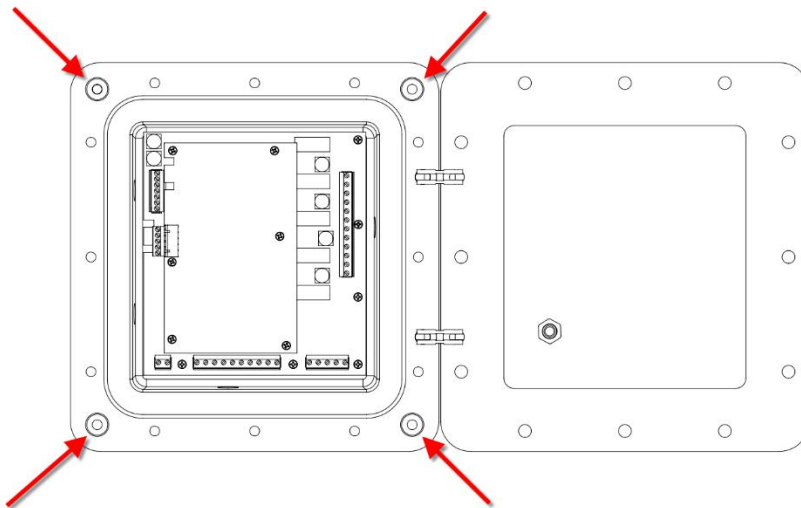

WARNING – WHEN CLOSING THE LID, ENSURE THAT NO WIRES ARE CAUGHT IN THE JOINT. TIGHTENING THE LID WHILE WIRES ARE IN THE FLAME PATH MAY IMPAIR SAFETY OR DAMAGE THE WIRES.

- Tighten all the screws and ensure that the monitor is secure.
- Do not close the lid until completing the electrical and configuration sections below.
- Once electrical installation and configuration are complete, close lid then install all 12 lid screws. Hand tighten the screws then torque all screws to the 'LID SCREW TORQUE' specified in

Technical Specifications section above, following the bolt pattern shown below:

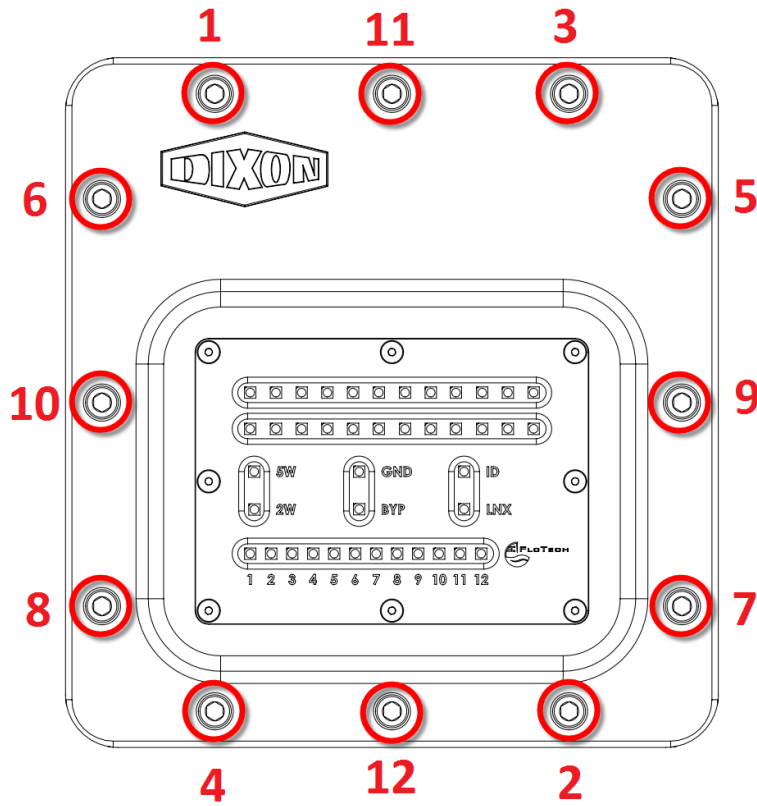

Electrical

ELECTRICAL INSTALLATION MUST BE COMPLETED BY HAZARDOUS LOCATION QUALIFIED ELECTRICIAN.

The electrical connections are designed to be a drop-in replacement for any existing rack monitor. Be sure to check that the relay contact limits are not exceeded by the equipment it is to control. Refer to the Technical Specifications section of this manual to find the output relay limitations.

Different regions will require different electrical installations. The installer should be familiar with local regulations and required install techniques:

- Sealing fittings required within 18" inches of the enclosure for North American installations. Un joint torique est requis à l'intérieur de 18" de l'entrée.
- Sealing fittings required at enclosure for ATEX/IECEx installations. Raccords d'étanchéité requis au niveau du boîtier pour les installations ATEX / IECEx.
- The supply connection to the FT7000 must be made with rigid metal conduit or armoured cable or other means which provides adequate equipotential bonding of the equipment. La connexion d'alimentation au FT7000 doit être faite avec un conduit métallique rigide, un câble blindé ou d'autres moyens qui fournissent une liaison équipotentielle adéquate de l'équipement.
- Any unused cable entries must use the included stopping plugs. Toute entrée de câble non utilisée doit utiliser les bouchons d'arrêt fournis.
- Installations that do not require conduit should use the provided cable glands and or equivalently approved hardware. Refer to the diagram and table below for correct use of the supplied cable gland.

Supplied Cable Gland Usage			
Sealing combination	S1 + S2 + S3	S1 + S2	S1
Sealing Diameter	0.39-0.47" [10-12mm]	0.47-0.57" [12-14.5mm]	0.57-0.63" [14.5-16mm]
Torque	18ft-lb [24Nm]	16ft-lb [22Nm]	13ft-lb [18Nm]

Sealing Combination

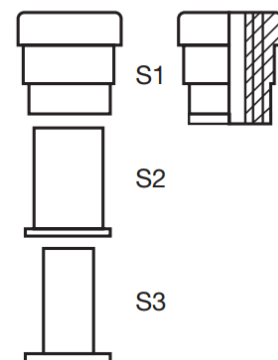

Apply a generous amount of grease to male threads of conduit or fittings, spread grease over entire surface of threads, thread into housing, then wipe away excess grease. Use Dixon 10613 grease or any lithium or silicone based corrosion inhibiting grease.

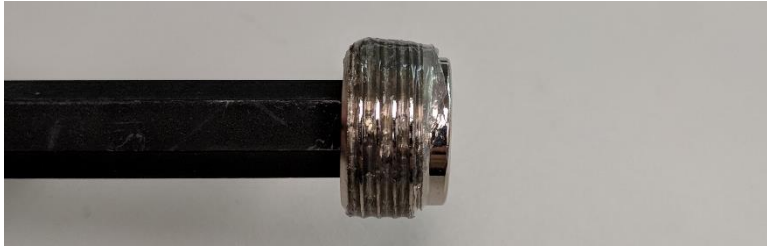

Mains supply must be fed from a circuit breaker protected line. The circuit breaker in-line with FT7000 must have a breaking capacity of 5,000A or more.



Terminals showing this symbol must be wired using cables rated for at least 194°F (90°C). Les terminaux avec ce symbole doivent être branchés avec des câbles approuvés à au moins 194°F (90 °C)

Each enclosure entry point is intended for a specific connection to the FT7000. Refer to the image below for **intended usage** and threading for each cable entry.

**DO NOT DEVIATE FROM THE INTENDED USAGE OF EACH CABLE ENTRY;
I.S. AND NON-I.S. CABLING MUST NOT USE THE SAME CABLE ENTRY.**

**NE JAMAIS INTERCHANGER LES ENTRÉES DE CÂBLES.
PAR EXEMPLE, LES CÂBLES I.S. ET NON I.S. NE DOIVENT PAS UTILISER LA MÊME ENTRÉE DE CÂBLE.**

TIP: The terminal block connectors can be removed for easier installation.

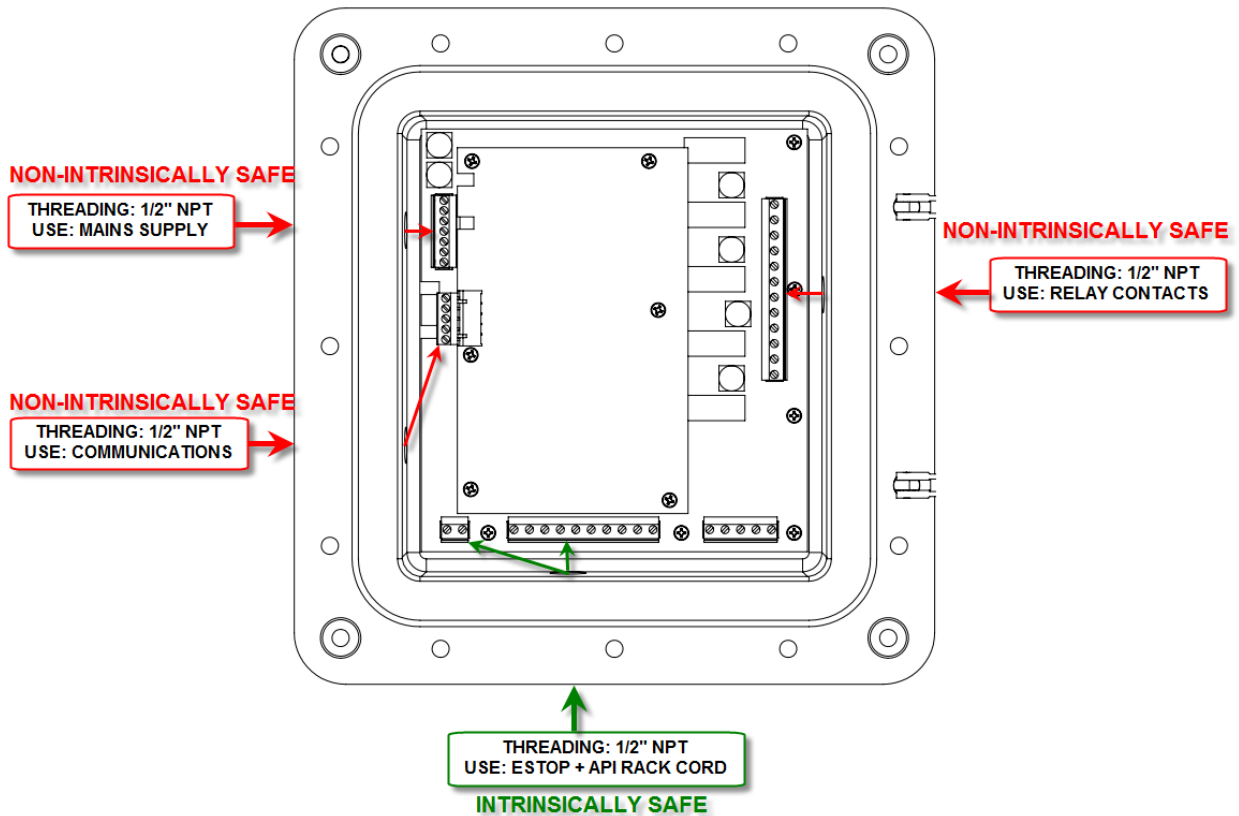

1. Install wiring into the appropriate terminals of J1 for your regions electrical service, referring to the diagrams below:

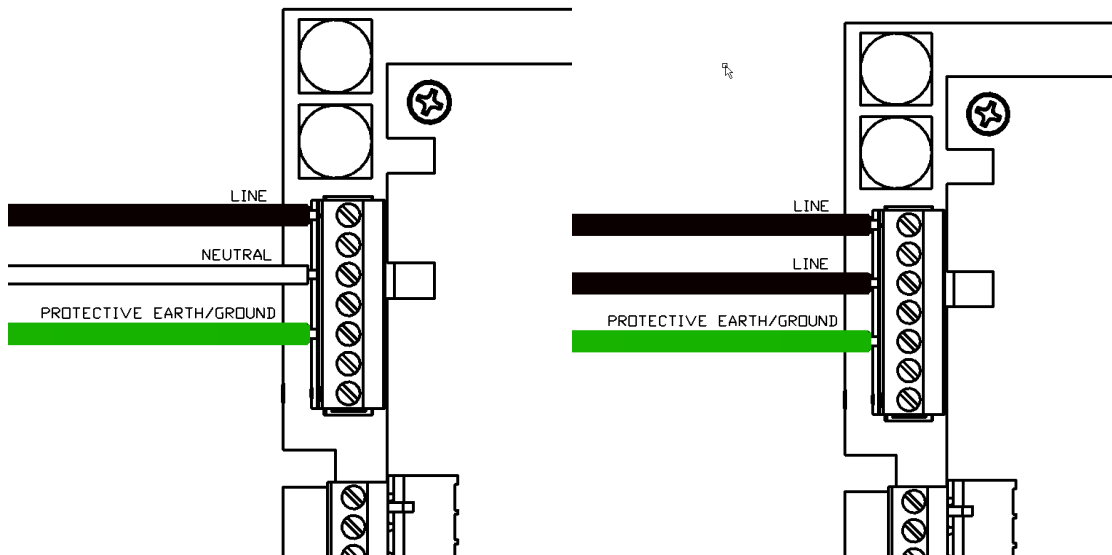

The FT7000 will autoswitch to work with the supply voltage.

2. Connect loads to the output relay terminal block J2, as necessary. Each relay is Single Pole Double Throw (Form C), having a common, normally closed, and normally open contact. Both permit relays are independent but operate in sync. Refer to the relay section above for more information. **Below are example wiring diagrams, but other configurations are possible.**

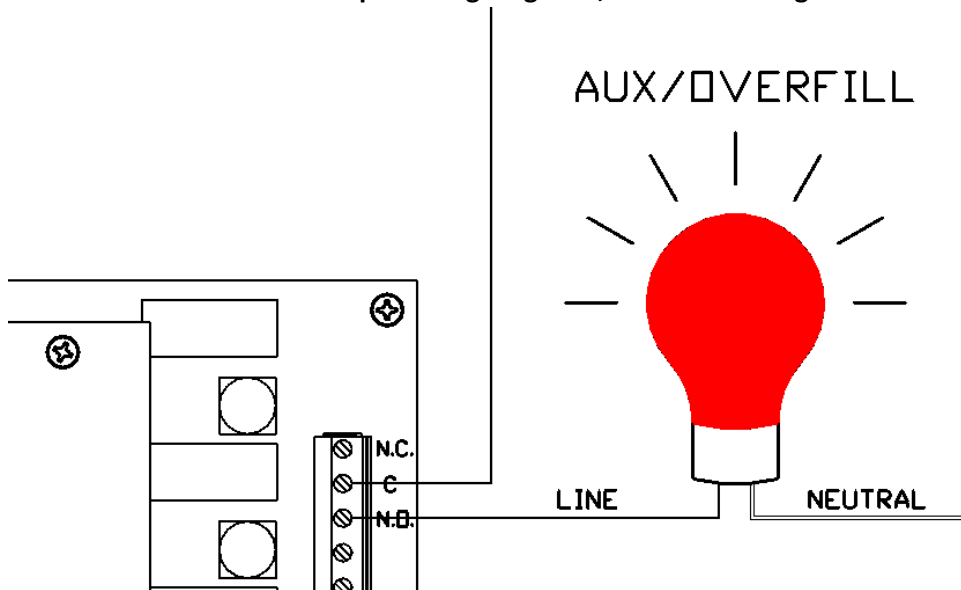

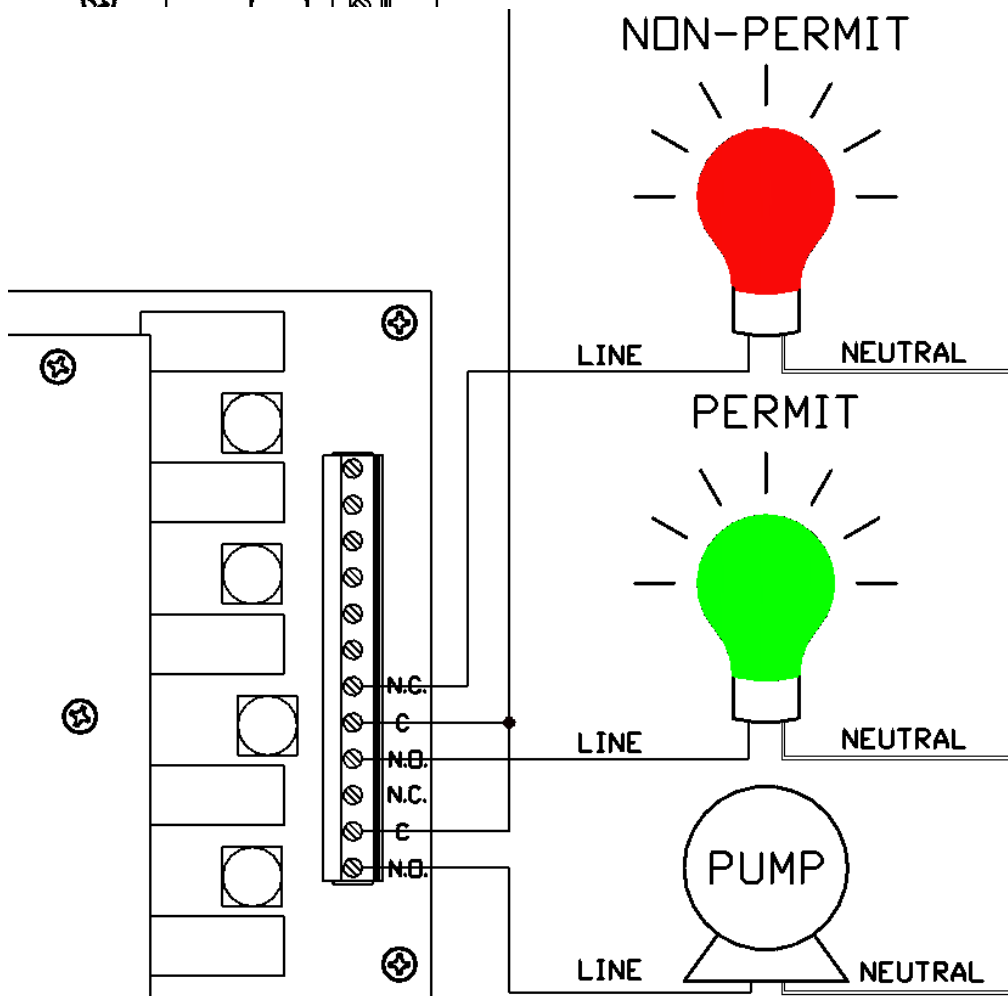
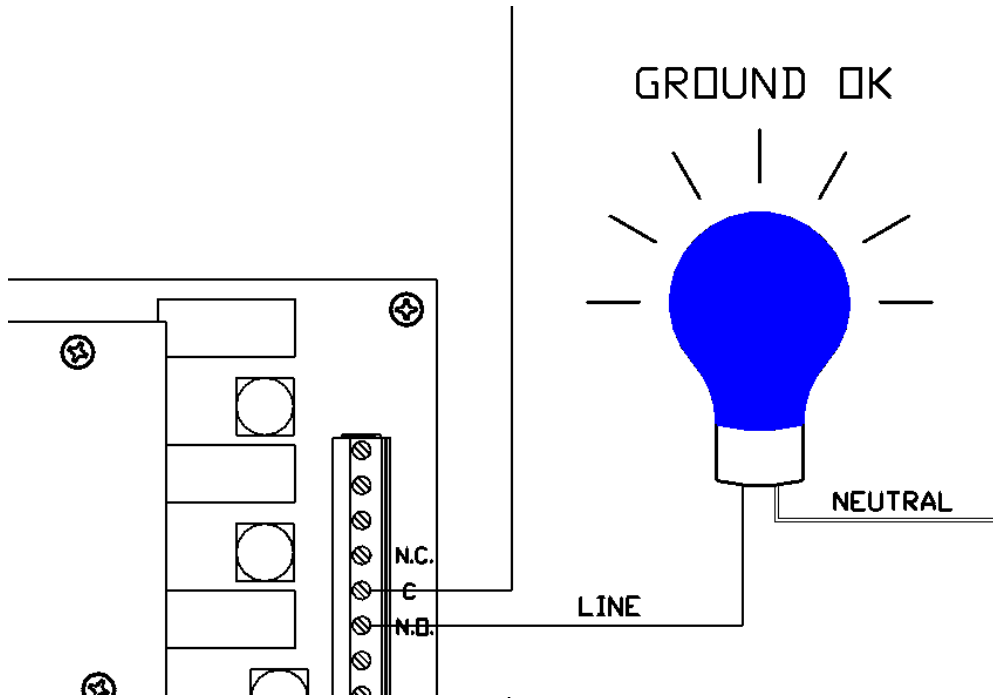

3. If the installation requires an ESTOP or DEADMAN switch, install the switch wires into the terminals of J9. Polarity does not matter for this connector. The deadman and estop wiring should exit the enclosure from the bottom Intrinsically safe enclosure entry.
4. Install the API rack cable connections into the API CABLE CONNECTION terminal J8 following the diagram below.

J8 (API CABLE CONNECTION) ON RACK MONITOR	API OPTIC WIRE COLOR (5 WIRE)	API THERMISTOR WIRE COLOR (2 WIRE)	FLOTECH RACK CORD WIRE COLOR*	J560 WIRE COLOR	J560 PLUG PIN LABEL	API RACK PLUG PIN NUMBER
1			RED W/BLACK			1
2			GREEN W/BLACK			2
3	BROWN - COMPARTMENT 1 SENSOR		WHITE W/BLACK	WHITE W/BLACK	BRN	3
4	YELLOW - PULSE TO SENSOR	GREEN - COMPARTMENT 2 SENSOR	GREEN	GREEN	GRN	4
5	GREEN - DIAGNOSTIC	RED - COMPARTMENT 3 SENSOR	RED	RED	RED	5
6	ORANGE - RETURN FROM SENSOR	YELLOW - COMPARTMENT 4 SENSOR	ORANGE	ORANGE	YEL	6
7		BLACK - COMPARTMENT 5 SENSOR	BLACK	BLACK	BLK	7
8	RED - SENSOR POWER	BLUE - COMPARTMENT 6 SENSOR	BLUE	BLUE	BLU	8
9	WHITE - GROUND BOLT/TIMODULE	WHITE - GROUND BOLT/TIMODULE	ORANGE W/BLACK	ORANGE W/BLACK	A(along side)	9
10	BLACK - SENSOR GROUND	WHITE - SENSOR GROUND	WHITE	WHITE	WHT	10

***WIRE COLORS ARE SPECIFIC TO DIXON/FLOTECH RACK CORDS. OTHER MANUFACTURERS MAY NOT FOLLOW THE SAME COLORING CONVENTION. REFER TO CORD MANUFACTURER'S DATASHEET**

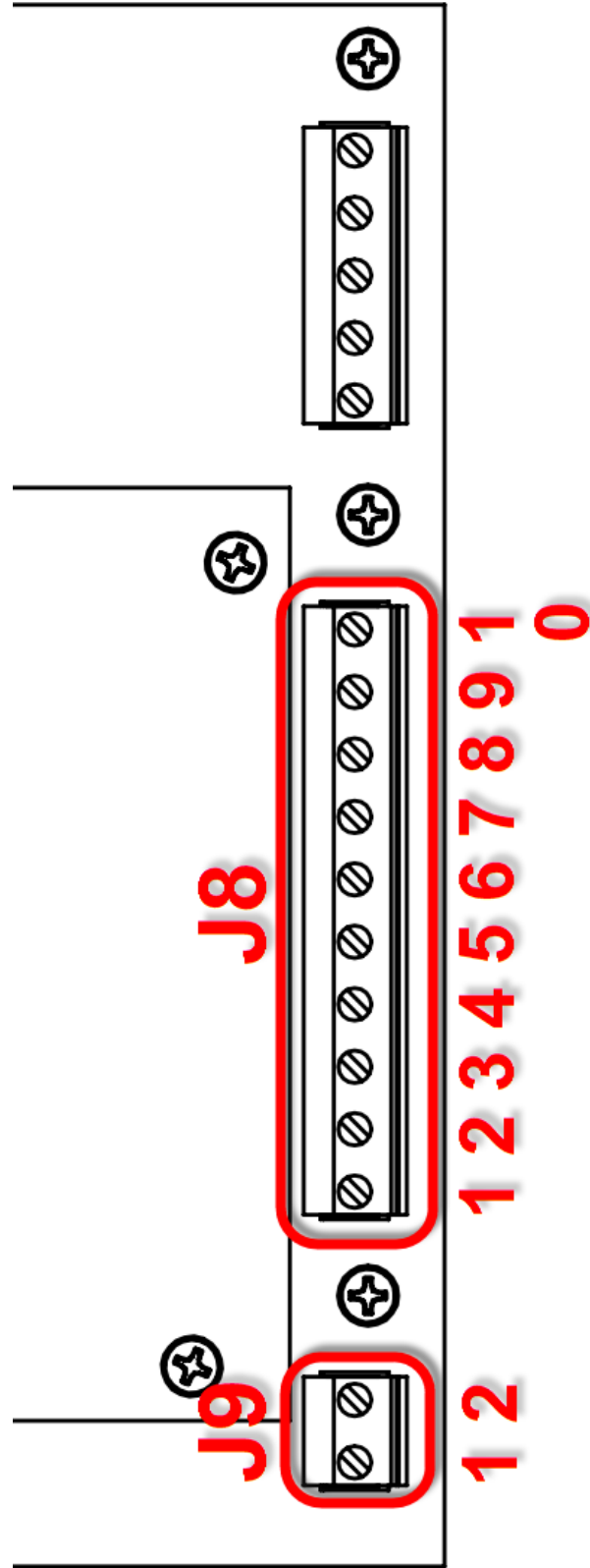

- If the installation requires Modbus or RS-485 connections for using remote viewing software, install the wiring into the RS-485 terminal J8, following the diagram below. **Modbus address must be set to an unused number to avoid malfunction.**

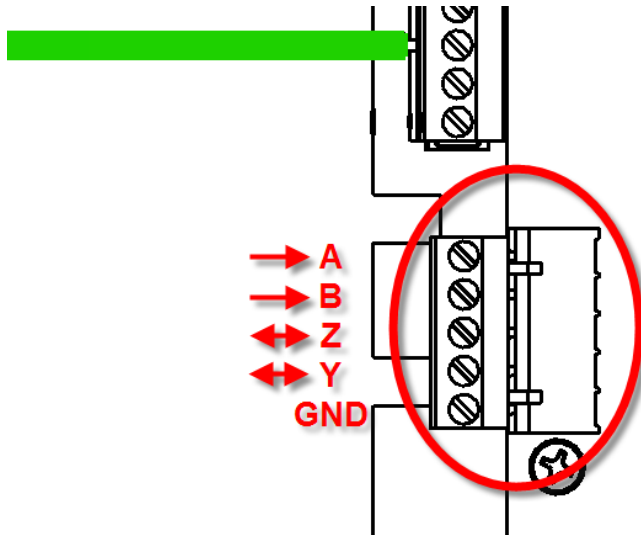

- Verify that all cable entries are sealed using a conduit fitting, cable gland, or stopping plug.
- Before closing the enclosure or energizing the FT7000, complete the configuration section below.

WARNING – WHEN CLOSING THE LID, ENSURE THAT NO WIRES ARE CAUGHT IN THE JOINT. TIGHTENING THE LID WHILE WIRES ARE IN THE FLAME PATH MAY IMPAIR SAFETY OR DAMAGE THE WIRES.

ALL CONDUIT AND CABLE GLAND THREADS TO BE INSTALLED INTO THREADED ENCLOSURE ENTRIES SHOULD USE TEFLON TAPE.

Configuration

The rack monitor operation is determined by setting the switches found inside the enclosure. The switches are divided into six sections. Each section contains related switches. The rack monitor must be powered off any time the enclosure is open. Do not modify the switches while the rack is in operation.

Each section of switches is outlined below, along with a more detailed explanation of each setting.

- **5-WIRE SENSOR CONFIGURATIONS**

- The FT7000 can display the wet/dry state of up to 12 five-wire sensors, and report up to 16 using the RackView software.
- The topmost switch next to “5W EN:” should be enabled to set the rack to autodetect.
- While configured to autodetect, the FT7000 will show green compartment indicators for each of the sensors found on the diagnostic wire. The first wet sensor will show red, and all remaining sensors will be off, as their state is unknown.
- If only a specific number of 5W sensors should be accepted, the ‘DIAG REQ’ switch should be turned ON, as well as the appropriate numbered switch in the 5W EN bank.
- Trailers having On-board monitors generally have no diagnostic wire, preventing the rack from determining the number of sensors. In this case the compartment indicators will be off.
- **Only one switch should be ON.**

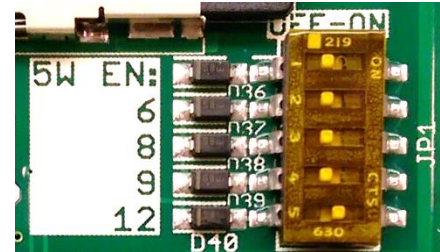

- **2-WIRE SENSOR CONFIGURATIONS**

- These switches determine the acceptable number of 2W sensors.
- The two topmost switches are not used.
- Moving a switch to the right will configure the monitor to allow trailers having the selected number of 2-Wire sensors.
- **Only one switch should be ON.**

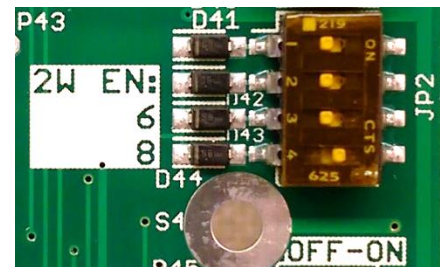

- **TImodule, GROUND LOOP/BOLT, EN13922, DIAG CONFIGURATIONS**

- If the **TIM ENABLE** switch is ON, the rack will require a validated TImodule as a ground device once the number is verified. This will require that valid serial numbers be added using the RackView software.
- If the **9-10 LOOP** switch is ON, the rack will accept trailers having API pins 9 and 10 bonded on the trailer. This connection should be less than 10KΩ.
- If the **GRND BLT** switch is ON, the rack will accept a ground-bolt/ground-wire/ground-ball as a valid ground device.

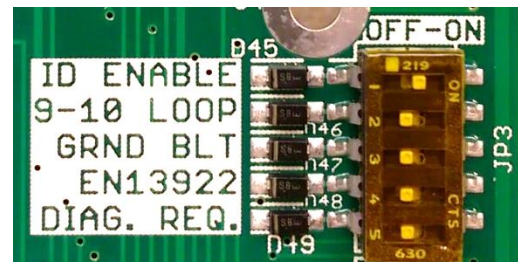

- If the ID enable, 9-10 LOOP, and GRND BLT switches are all off, the rack monitor will not check for any grounding device and assumes the API cable grounding is good.
- With the **EN13922** switch in the ON position, the rack will check the trailer's overfill prevention system against the requirements outlined in BSI standard EN13922. Some overfill equipment may not meet these requirements and will not create a permissive loading state unless the EN13922 switch is set to OFF. In the off position, the tolerances of acceptability are widened, however the operation of the rack is similar.
- If the **DIAG REQ** switch is ON, 5W overfill systems will require a specific number of 5W sensors in addition to a valid permissive signal return. The valid number of sensors is determined by setting the first bank of switches.

• **ESTOP, NEW TAG, COMMS CONFIG**

- If the **ESTOP** switch is to the right(ON), the rack will treat the connected button as an ESTOP switch. A ESTOP switch should be normally-open. The monitor will latch the estop if the button is pressed, until a bypass card is used to remove the ESTOP.
- If the **ESTOP** switch is to the left(OFF), the rack will treat the connected button as a deadman switch. The deadman switch should be normally open and must be held at all times to enable the rack's output relays.
- The **NEW TAG** switch is used in the bypass key pairing process. Under normal operation the switch should be to the left(OFF).
- The protocol switch is intended for future use and should be in the left(OFF) position to select 9 bit data packets for normal Modbus operation. Moving the switch to the right will change the communications to 8 bit packets.
- If the **NO/EVEN** switch is right(ON), communication packets will have an even parity bit. If the **NO/EVEN** switch is left(OFF), communication packets will have an odd parity bit.



• **BAUD RATE**

- The 9600, 19200, 38400, 57600, and 115200 switches will determine the communication rate that packets will be delivered and received to and from the rack monitor.

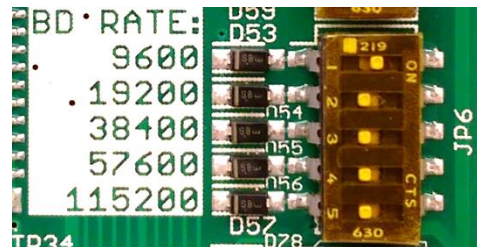

• **DUPLEX, TERMINATION RESISTORS**

- The **FULL/HALF** switch will configure the rack to simultaneously transmit and receive data with the terminal automation system when in the left(FULL) position. Moving the switch to the right(HALF) will limit the communication to half duplex.
- The **RX TERM** and **TX TERM** switches will add 120Ω termination resistors to the RX and TX communication pairs when in the right(ON) position.

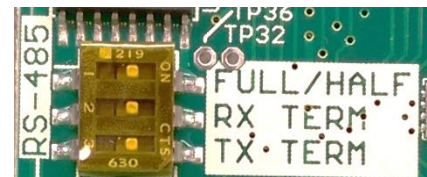

- **MODBUS ADDRESS SETTING**

- The rack monitor can be connected to a Modbus system to enable remote viewing.
- Once the rack monitor has been connected to the Modbus data bus, the Modbus address must be set to a unique number so that no interference will occur on the Modbus data lines. Select the 10's from the top switch and the 1's from the bottom switch. The above image shows a Modbus address setting of 32.

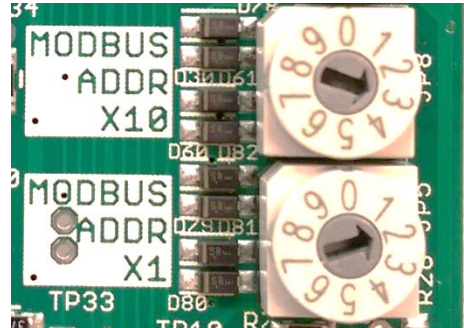

Maintenance

**SERVICE SHOULD BE COMPLETED ONLY BY A QUALIFIED HAZARDOUS LOCATION TECHNICIAN.
LE SERVICE DOIT ÊTRE COMPLÉTÉ PAR UN TECHNICIEN QUALIFIÉ.**

**DO NOT OPEN ENCLOSURE WHILE UNIT IS ENERGIZED.
NE PAS OUVRIR LE BOÎTIER QUAND L'APPAREIL EST ALIMENTÉ.**

**DO NOT OPEN ENCLOSURE WHILE EXPLOSIVE ATMOSPHERE IS PRESENT.
NE PAS OUVRIR LE BOÎTIER DANS UN ENVIRONNEMENT EXPLOSIF.**

**DO NOT TOUCH OR CLEAN THE EQUIPMENT WHILE EXPLOSIVE ATMOSPHERE IS PRESENT.
NE TOUCHEZ PAS ET NETTOYEZ PAS L'ÉQUIPEMENT LORSQUE L'ÉQUIPEMENT EST DANS UN
ENVIRONNEMENT EXPLOSIF.**

**REPLACE PARTS WITH GENUINE DIXON OR APPROVED EQUIVALENT PARTS; SUBSTITUTION MAY
IMPAIR INTRINSIC SAFETY.
DIXON OU UN ÉQUIVALENT APPROUVÉ SONT LES SEULES RECOMMANDÉES POUR LE REMPLACEMENT
DES PIÈCES; LA SUBSTITUTION PEUT EMPÊCHER L'EFFICACITÉ ET LA SÉCURITÉ.**

**DO NOT REPAIR ANY FLAMEPROOF JOINTS; REPAIR MAY IMPAIR ENCLOSURE'S FLAMEPROOF
PROTECTION. CONTACT DIXON IF FLAMEPROOF JOINT IS DAMAGED.
NE RÉPAREZ PAS LES JOINTS À L'ÉPREUVE DES FLAMMES; CECI PEUT EMPÊCHER LA PROTECTION ANTI-
INFLAMMABLE DE LA PIÈCE. CONTACTEZ DIXON SI LE JOINT ANTI-INFLAMMABLE EST ENDOMMAGÉ.**

The FT7000 has few parts that will require regular maintenance, however it is important to service annually to extend the life of the monitor. Unsheltered units should be serviced in dry weather to prevent rainwater from entering the enclosure and minimize moisture exposure.

1. Once the unit has been powered down and hazardous gases have dissipated, remove the 12 lid screws.
2. Open the lid, then verify the O-ring gasket is in good condition and secured into the O-ring track. If the O-ring is loose or damaged, replace and secure using ordinary superglue.
3. Inspect the interior of the enclosure for condensation or pooled water. The presence of water will cause corrosion and/or failure and should be fixed immediately.
If water or condensation is present, replace O-ring, inspect cable entry threads and reapply corrosion inhibiting grease if needed. For conduit installations, verify the conduit-sealing fitting is filled. For non-conduit installations, verify the cable gland is tightened properly to seal against the cable jacket. If necessary, add sealing compound to fortify water tight seal. Re-inspect after next rain to ensure water has not entered the enclosure. If water still enters enclosure, contact Dixon support for further assistance.

4. Inspect flame path for coating of grease. If the flame path is not thoroughly coated, apply a lithium or silicone based grease to the areas highlighted. Recommended grease: Dixon 10613.
5. Replace corrosion inhibiting foam.
6. Verify all wire terminals are tight.
7. Replace any fuses necessary, referencing the diagram below

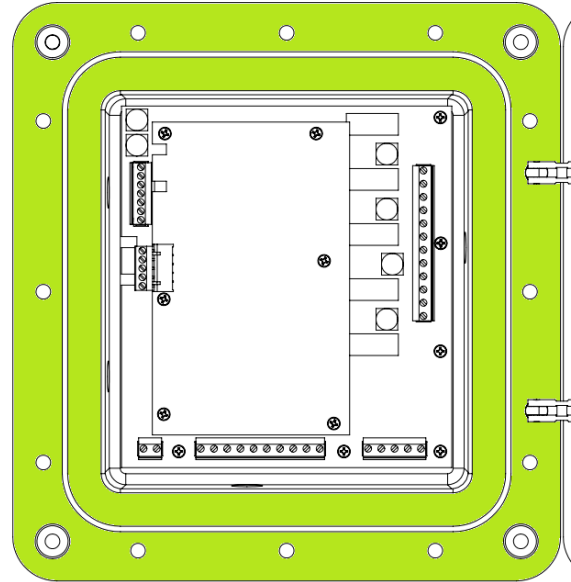

AREAS TO APPLY GREASE

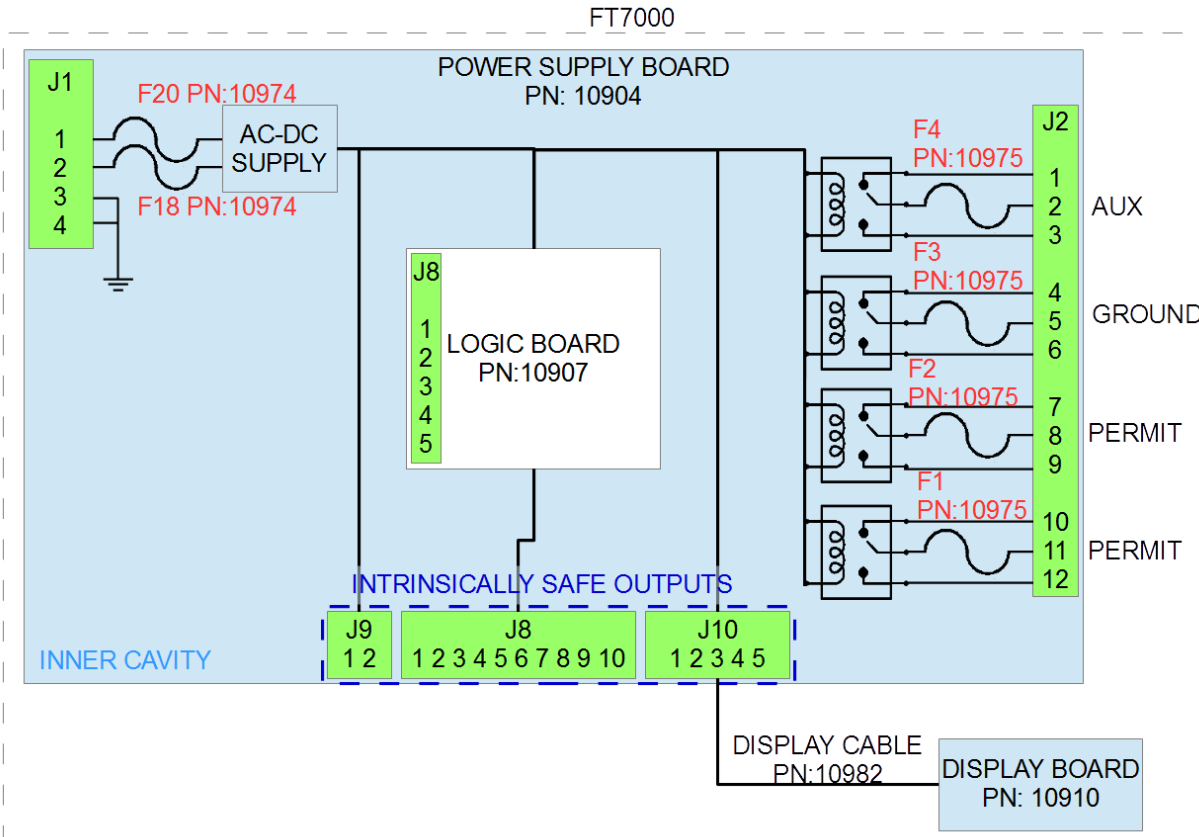

8. Replace corrosion inhibitor.
9. Close lid, and tighten all 12 lid screws.
10. Restore power to unit.

Replacement Parts

- **CORROSION INHIBITOR – Replacement Part Number: 10977**

This rack monitor comes with a corrosion inhibitor located inside of the enclosure. This inhibitor must be removed from its' plastic packaging once the rack is properly installed. The inhibitor should be replaced every 12 months for continual protection of the monitor's electronics. This will help to extend the life of the rack monitor.



- **FUSES – Replacement Part Number: 10974/10975**

The stated rating for all replaceable fuses should not be exceeded, however if a fuse does burn out, replace the fuse with a Dixon brand or Dixon approved fuse. Replacing the fuse with a non-approved fuse may alter the normal operation of the monitor or impede the intrinsic safety of the device.

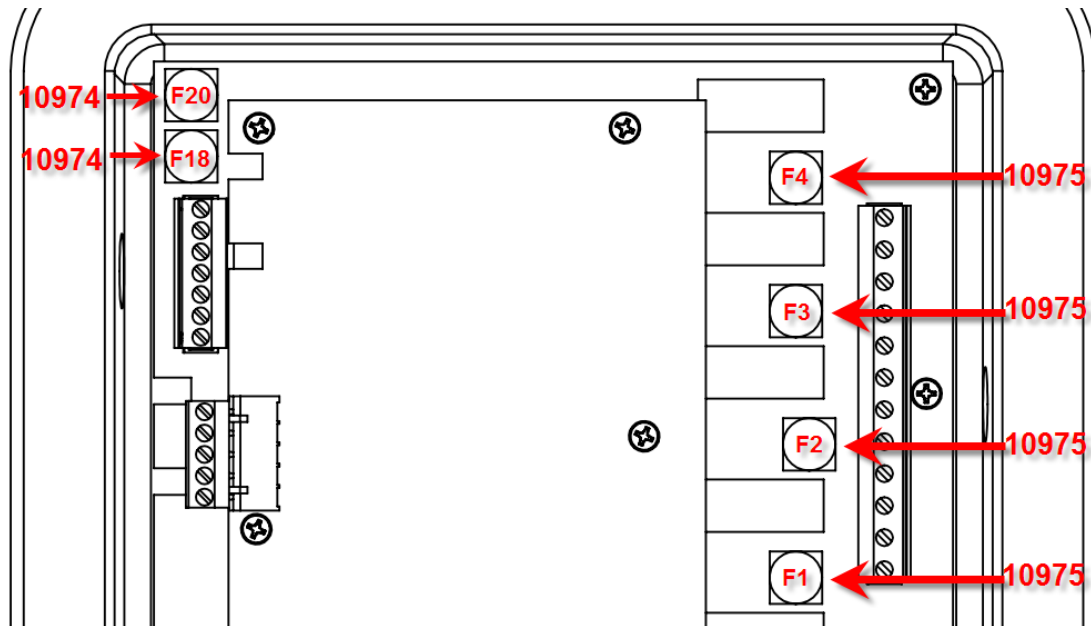

To replace the fuse:

1. Use a flat-head screwdriver to push down and turn the fuse holder cap approximately 1/8th of a turn.
2. The cap will pop out, allowing the cap and internal fuse to be removed.
3. Separate the bad fuse from the cap, discard the old fuse, and replace with an approved fuse.
4. Insert the fuse and cap into the fuse-holder.
5. Use a flat-head screwdriver to push down and turn the cap into place.

- **SD CARD – Replacement Part Number: 10976**

The rack monitor is outfitted with an SD card reader. The reader will accept standard size SD, SDHC, and MMC cards. Cards may be formatted to FAT, or FAT16.

The SD card is used to log the time that the rack monitor changes relay states. Details the SD log will record:

- The time that any output relay changes states
- The type of sensors connected at the time of relay change
- Type of ground connected at time of relay change
- TIM serial number at time of relay change
- WET/DRY status of sensors at time of relay change

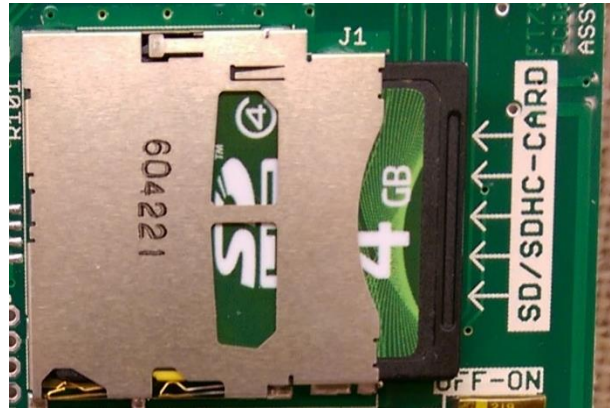

The SD card may also function as a means to update the rack monitor’s software. The current software version is visible when powering on the rack monitor. It will show the four version numbers sequentially in red. Zero will show as compartment 10.

Contact Dixon support to find if a newer version of the software is available.

- **OVERFILL BYPASS CARD – Replacement Part Number: 10964**



- **GROUND BYPASS CARD – Replacement Part Number: 10978**



The rack monitor comes with two overfill bypass key cards and two ground bypass key cards. For bypass instructions refer to the ‘Bypass Procedure’ section below.

- If one or both cards are lost and replacement card(s) are ordered, the replacement card(s) must be paired to the monitor by following the bypass card pairing procedure below.
- The monitor may only be paired with one overfill bypass card and one ground bypass card at a time.
- Pairing a ground card can be done with only a ground card present, but pairing an overfill card requires a ground card and an overfill card to be present during the pairing process.
- **Silicone Dielectric Grease Packet – Replacement Part Number: 10613**



Description	Part Number
CORROSION INHIBITOR	10977
SILICONE DIELECTRIC GREASE	10613
SUPPLY FUSE 3.15A SLOW-BLO	10974
RELAY CONTACT FUSE 5A	10975
SD CARD	10976
GROUND BYPASS CARD	10978
OVERFILL BYPASS CARD	10964
LID SCREW	10968SS
O-RING	10476EP
CABLE GLAND	10962BR
STOPPING PLUG	10963BR
DISPLAY CABLE ASSEMBLY	10982
DISPLAY ASSEMBLY	11172
LOGIC BOARD	10907
POWER SUPPLY BOARD	10904

Managing Bypass Cards

The FT7000 Rack Monitor will come from the factory with two Ground Bypass cards and two Overfill bypass cards paired to the monitor. These cards do not require pairing and will work with the monitor out of the box.

If a card needs to be added, removed, or replaced, the monitor must be put into pairing mode. Entering pairing mode for any reason will remove all currently paired bypass cards. It will be necessary to re-pair ALL bypass cards if the monitor is put into pairing mode.

1. Begin by powering off the rack monitor.
2. Remove the 12 lid screws and open the lid to access the configuration switches.
3. Move the 'NEW TAG' switch to the right(ON) position.
4. Close the rack monitor lid.
5. Restore power to the rack monitor.
6. One at a time, place a bypass card in front of the bypass indicator on the monitor, then remove the card.
7. With each successive swipe of the card, the bypass indicator will cycle blue -> red -> off -> blue...
The blue bypass light indicates that the card is recognized as a ground bypass card, while the red bypass light indicates the card is recognized as an overfill bypass card.
8. Repeat step 7 with all bypass cards to be used with the monitor.
9. Remove power from the rack monitor.
10. Open the lid to access the configuration switches.
11. Move the 'NEW TAG' switch to the left(OFF) position.
12. Close the rack monitor lid.
13. Screw in the 12 lid screws.
14. Restore power to the rack monitor.

Operation

WARNING - USING THE FT7000 IN A MANNER NOT DEFINED IN THIS MANUAL MAY IMPAIR SAFETY.
AVERTISSEMENT- L'UTILISATION DU FT7000 D'UNE MANIÈRE NON DÉFINI DANS CE MANUEL POURRAIT NUIRE À LA SÉCURITÉ

While loading a trailer, the front of the FT7000 will indicate the status of the monitor's outputs, as well as the trailer's sensors and accessories.

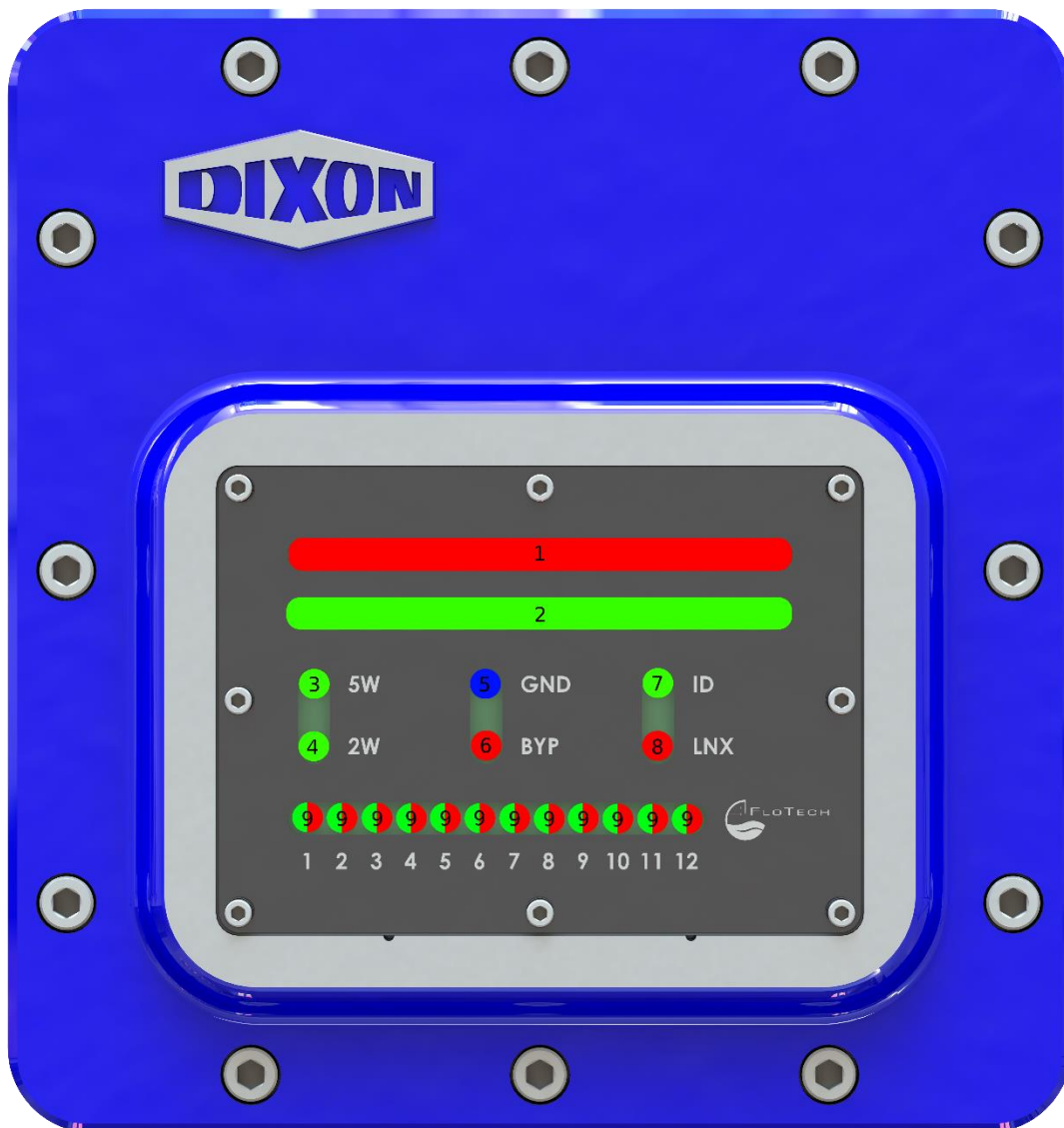

1. **NON-PERMIT** – The top row of indicators will illuminate red to reflect the state of the permit relays. While the indicators are on, the permit relays are de-energized.

2. **PERMIT** – The second row of indicators will illuminate green to reflect the state of the permit relays. While the indicators are on, the permit relays are energized.
3. **5WIRE SENSOR MODE** – Illuminates to indicate a trailer having 5 wire sensors has been attached and identified.
4. **2WIRE SENSOR MODE** – Illuminates to indicate a trailer having 2 wire sensors has been attached and identified.
5. **GROUND-OK** – The GND indicator will illuminate blue to reflect the state of the ground relay. While the indicator is on, the ground relay is energized. If no ground configurations are enabled the ground indicator and relay will be active constantly.
6. **BYPASS ACTIVE** – Indicator shows red when Overfill bypass is active, and blue when Ground bypass is active.
7. **ID FOUND** – The ID indicator will show green when a valid trailer identification module is found. When an unknown or expired trailer identification module is found the indicator will flash.
8. **OVERFILL DETECTED** – The LNX indicator reflects the state of the LINX relay contacts. When active, the attached trailer became non-permissive and is still attached.
9. **COMPARTMENT INDICATORS** – Each compartment indicator can show either red or green to show the wet or dry status of the sensors, respectively. Indicators will be off if the compartment/sensor is not found, or unknown.

Loading Procedure

The rack monitor will default to a NON-PERMISSIVE mode. While non-permissive, the non-permit indicator will be illuminated and the rack will continually check for 5-Wire and 2-Wire trailers.

Once the monitor is connected to a trailer it will identify the type of sensors (5Wire or 2Wire) and lock into that mode. The detected sensor type will be indicated by a green light next to 5W or 2W on the front of the monitor. Trailers having 2W analog sensors may take longer to identify, as the sensors must warm up before they activate. The monitor will then verify the incoming signals from the sensors/monitor are within the acceptable tolerances.

The monitor will continuously check for any of the enabled ground devices. If no ground devices are enabled in the monitor configuration, the monitor not require any ground verification to become permissive. Once a valid ground device is found, and the overfill sensors are detected as dry, the monitor will become permissive.

The FT7000 will remain permissive until any requirement is lost. During a normal load, the FT7000 will remain permissive throughout the entire load, then become non-permissive as the trailer disconnects.

While the monitor is permissive it will continually verify that the overfill sensors are dry, and the ground device is connected. If a sensor becomes wet, the monitor will immediately become non-permissive. While the sensor is wet, and the trailer is still attached to the rack, the LINX feature will activate to indicate an overfill has likely occurred.

NOTE: INTERMITTENT CONNECTIONS WILL PREVENT THE MONITOR FROM STAYING PERMISSIVE THROUGHOUT A LOAD.

NOTE: IF AN ESTOP IS TRIGGERED, THE MONITOR WILL BE LOCKED IN THIS STATE UNTIL A BYPASS KEY IS READ BY THE MONITOR.

Bypass Procedure

If a trailer cannot satisfy the requirements of the monitor, a bypass function will allow the monitor to become temporarily permissive.

If a terminal operator has deemed the trailer as safe, and chooses to bypass the safety checks provided by the FT7000, the operator will hold their bypass card to the bypass indicator. Once the FT7000 has read the bypass card, and verified it is paired, the unit will enter bypass mode.

Ground bypass cards can only enter ground bypass mode, indicated by a blue bypass light.

Overfill bypass cards can only enter overfill bypass mode, indicated by a red bypass light.

Once the FT7000 has been put into bypass mode, any of the following conditions will end the bypass:

- A trailer sensor becomes wet
- Rack cord is disconnected from trailer
- Any paired bypass card is scanned again
- 30 minutes has elapsed

CAUTION: ENTERING BYPASS MODE MAY ALLOW UNSAFE CONDITIONS TO OCCUR!

ATTENTION: L'UTILISATION DU MODE « BYPASS » PEUT ENGENDRER DES SITUATIONS NON SÉCURITAIRES.

FAQ & Troubleshooting

- Lost bypass card
 - If the lost bypass card needs to be deactivated for security reasons, the operator will need to repair all remaining bypass cards. Powering on the monitor while in pairing mode clears all paired bypass cards. Follow the pairing procedure to pair each active card. Up to 10 bypass cards total can be paired to the monitor.

- Monitor output does not change, even though display does.
 - The relays are all protected by fuses located in the enclosure. Disconnect power, open the enclosure, and verify fuses F1, F2, F3, and F4 are all intact. Refer to the maintenance section of this manual if any fuses need to be replaced.
 - In extreme cases, a permit relay contact could become welded together. Should this occur, the system will detect a failure and enter a failsafe mode to prevent further damage or unsafe operation. Please contact Dixon support if this is the suspected failure.

- No lights are showing when powering on the monitor
 - Power off the monitor, then open the enclosure. Check that fuses F18, and F20 are intact. Refer to maintenance section of this manual if any fuses need to be replaced.

- ESTOP occurred and monitor appears to be stuck non-permissive
 - A bypass card is necessary to exit failsafe mode. Hold up either the Overfill bypass card or the Ground/TIM bypass card to the bypass indicator to reset the ESTOP lock.

- The lid will not open.
 - Once the lid screws are removed the lid should droop slightly and rest on the hinges. If the hinges have become out of alignment with the lid opening direction, the lid will not pivot open. To realign the hinges, pull the lid away from the base of the box, then use a 7/16" [12mm] open-end wrench to rotate the hinge until the lid can open.

Warranty

For warranty claims and information regarding coverage, please contact Dixon Support at

+1 (513) 874-8499

Support

Dixon Bayco

7280 Union Center Blvd

West Chester Ohio 45014

+1 (513) 874 8499